



WAKAFLEX

INSTALLATION GUIDELINES

1. WAKAFLEX COMPOSITION

Wakaflex is a rolled six-sheet laminate consisting of Polyisobuthylene (PIB) with an internal aluminium mesh insert and butyl adhesive strips running along both underside edges.

Available widths (mm): 280 / 370 / 560

Available lengths (m): 5m only

Approximate weight: 3.24 kg/m²

Colours: Lead Grey / Black / Terracotta / Brown

Stretch: 50% in Length, 15% in width

Laminate layer:

1. Upper layer - Polyisobuthylene extrusion foil 1.10 mm
2. Upper center layer - Aluminum metal mesh 1.00 mm
3. Lower center layer - Polyisobuthylene extrusion foil 0.55 mm
4. Lower layer - Sticky adhesive layer (synthetic rubber based)
5. Adhesive fixing strips - Butyl adhesive (synthetic rubber)
6. Protective layer - HDPE white protective foil, must be removed prior to install

2. BASIC LAYING PROCEDURE

The following installation recommendations are a guide only. The responsibility to ensure all work carried out complies with Australian building codes and state regulations is the sole responsibility of the building, plumbing or roofing contractor.

INSTALLATION TIPS

1. Wakaflex can be installed in complete 5m roll lengths.
 2. Overlaps should be 50mm and pressed together firmly to fuse together.
 3. Stretch the internal aluminium mesh to the shape of the roof for a lasting watertight profile.
 4. Perforated protective backing should be kept on as long as possible to keep butyl adhesive clean.
 5. Wakaflex can be painted with a suitable outdoor acrylic once installed. Sikaflex Pro Polyurethane can be used as an additional sealant. Silicone is not recommended.
 6. Wakaflex should be built-in horizontally for abutments and vertically for step-flashing.
- **WAKAFLEX MUST** always be built/chased into brickwork or mechanically over-flashed.
 - **DO NOT** allow any load post installation to rest on or indent the wakaflex surface ie tile stub resting on the WF
 - **DO NOT** stick masking tape onto Wakaflex surface.
 - **ALWAYS** clean mortar, concrete and paint debris from surface immediately.
 - **DO NOT** install on a roof with a pitch of less than 12 degrees

1. Ensure application area is clean and dry.
2. Form Wakaflex to basic shape of roof and remove the first (top) section of the protective backing.
3. Place Wakaflex into position. Firmly fix top butyl strip into place and slowly remove the remaining protective backing. Only remove protective backing from section you're working on.
4. Dress Wakaflex firmly by hand to stretch the aluminium mesh over the roof profile. Ensure a tight fit over the substructure. A wallpaper roller can be used if required.
5. Apply firm pressure to the lower butyl strip to create a watertight seal against the roof
6. For joints, overlap by a minimum of 50mm and add pressure. Wakaflex will immediately adhere to itself and permanently cure in 15-20 minutes.

3. RETRO-FIT

NOT REMOVING EXISTING LEAD

1. Lift up existing lead flashing as much as possible exposing the underlying junction between the roof and wall structure.
2. Remove the top white section of protective backing and adhere Wakaflex against the brickwork as close as possible to the underside of the protruding lead flashing.
3. Using a small roller or hands, apply firm pressure along the butyl sealing strip to gain the best adhesion against the brick surface.
4. Remove the middle section of the protective backing and using the roller or hands dress the Wakaflex down firmly against the brick wall and the beginning of the tile roof surface. Make sure there are no large gap or air pockets behind the Wakaflex.
5. Remove the final lower section of protective backing to expose the lower butyl strip and make sure the Wakaflex roll is evenly bridged across the peaks of the tile or metal roof profile. Press down on these peaks to ensure a good adhesive seal as achieved across all the peaks along the whole length of flashing without pushing into the troughs.
6. Starting roughly in the middle of the flashing section, dress down the first 3 inches (7.5 cm) of Wakaflex into the troughs of the roof surface ensuring the Butyl adhesive has a firm contact with the roof. Dress firmly by hands to stretch the aluminium mesh inside Wakaflex, this is required to achieve a complete watertight seal along the whole flashing. Wakaflex should always be flush to the surface of the tile to ensure no water ingress.
7. If overlaps are required, ensure there is a minimum of 50mm overlap of material and press down firmly. The overlapped materials will adhere to each other immediately and cure together in 15-20 minutes. If a mistake is made the lap can be peeled open for the first 2 minutes.
8. Dress the existing lead flashing back down over the top of Wakaflex. You can trim the existing lead ensuring a minimum of 50mm remains as an over-flashing that is dressed firmly over the top of the Wakaflex against the brickwork.

REMOVING EXISTING LEAD

1. Cut away any existing lead with metal snips as close to the wall face as possible. Smooth down the edges or recess onto the wall using an angle grinder. Then either:
 - a. Reinstall Wakaflex into the newly recessed brick course and back fill using mortar, butyl strip or Sikaflex Pro, then dress down to brickwork and roof as directed above.
 - b. Using an angle grinder, chase a recess into the cement between the brick course above or below the existing lead flashing level. Install Wakaflex into the recess and backfill as above.

4. CHIMNEYS - BCA DIAGRAM

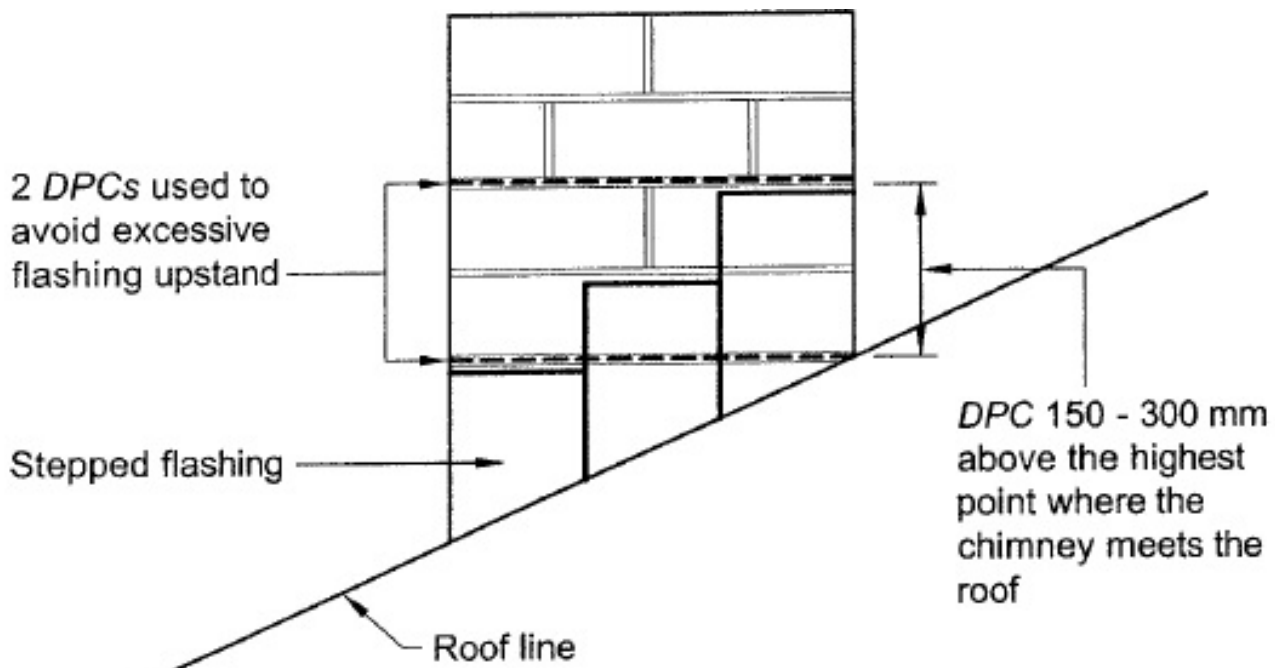

(a) Elevation

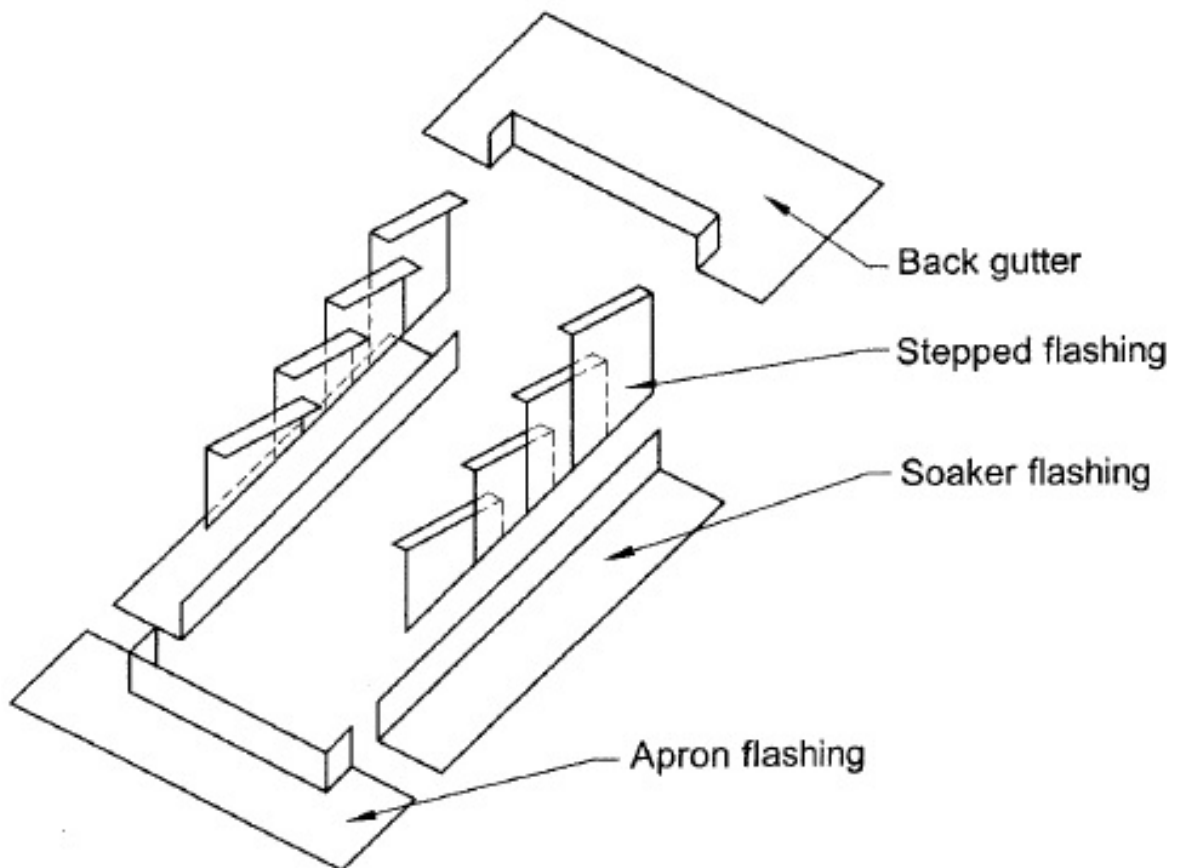

5. ABUTMENTS & PARAPET WALLS – BCA DIAGRAM

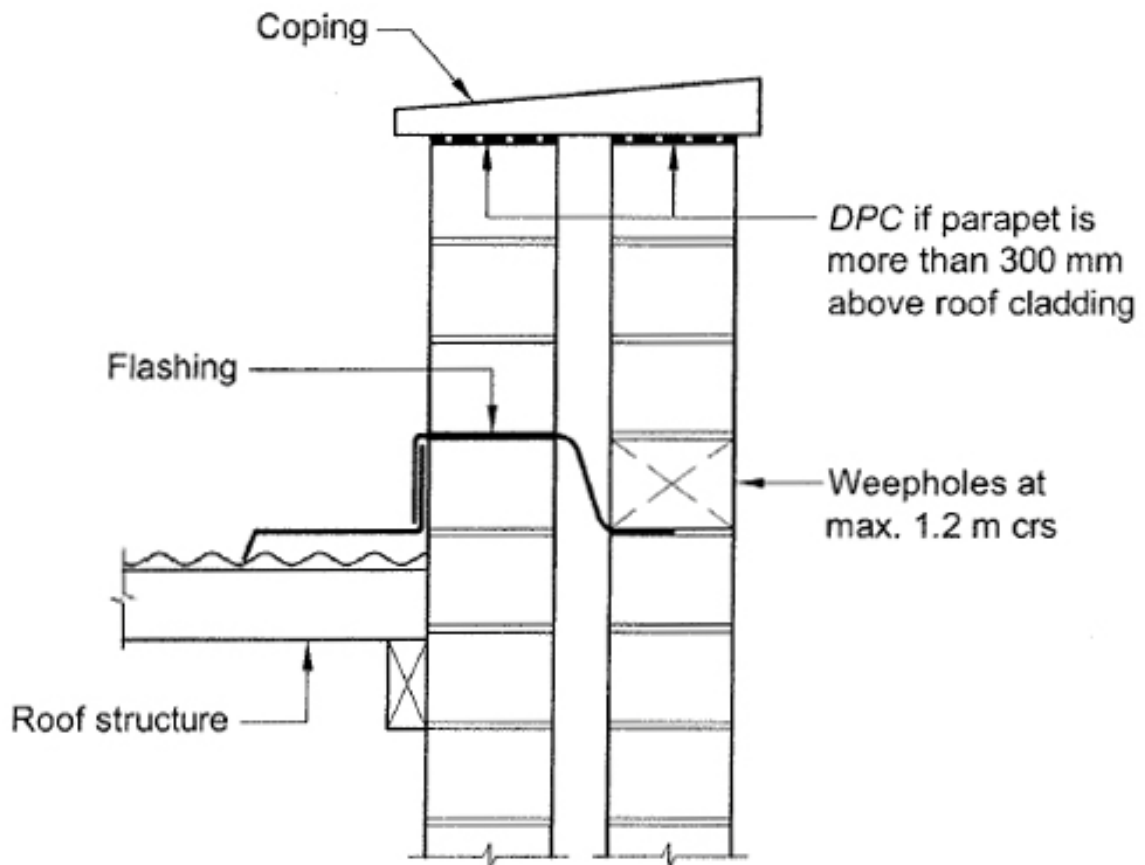

Option (a)

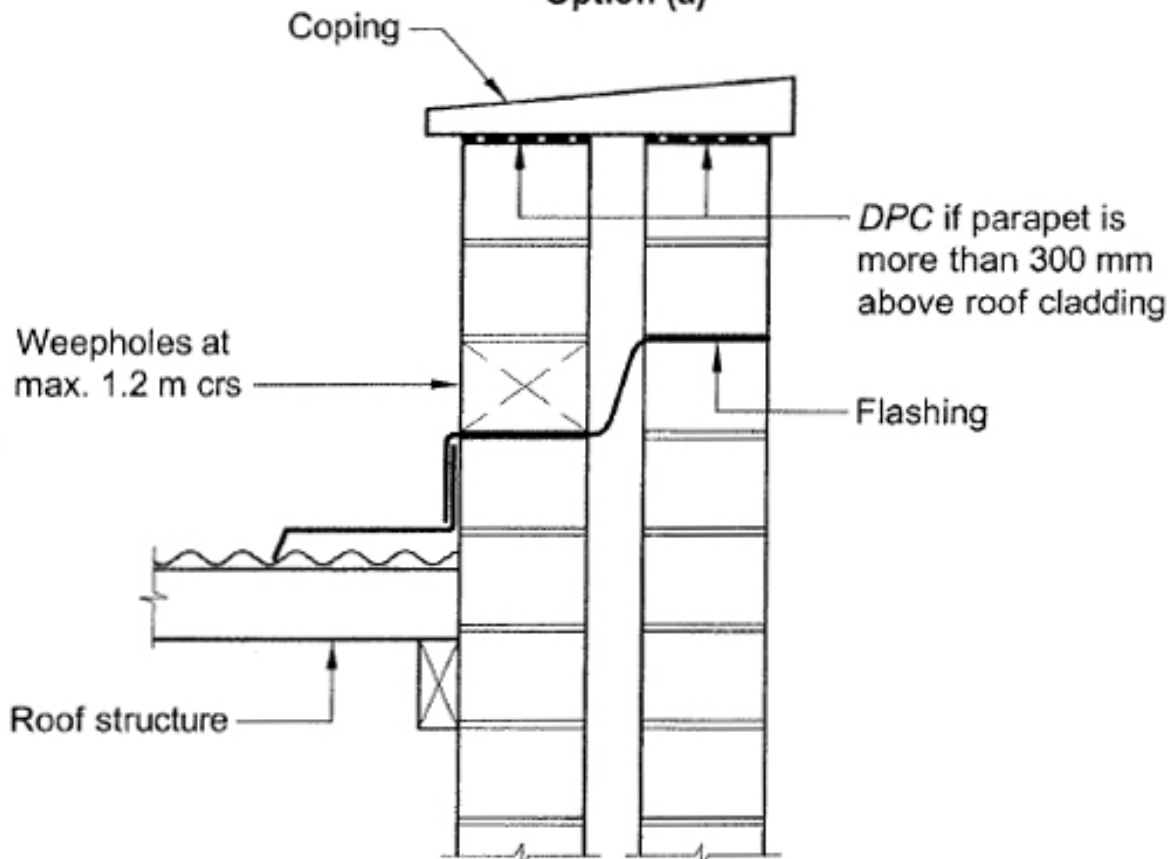

Option (b)

6. SILL & HEAD FLASHINGS - BCA DIAGRAM

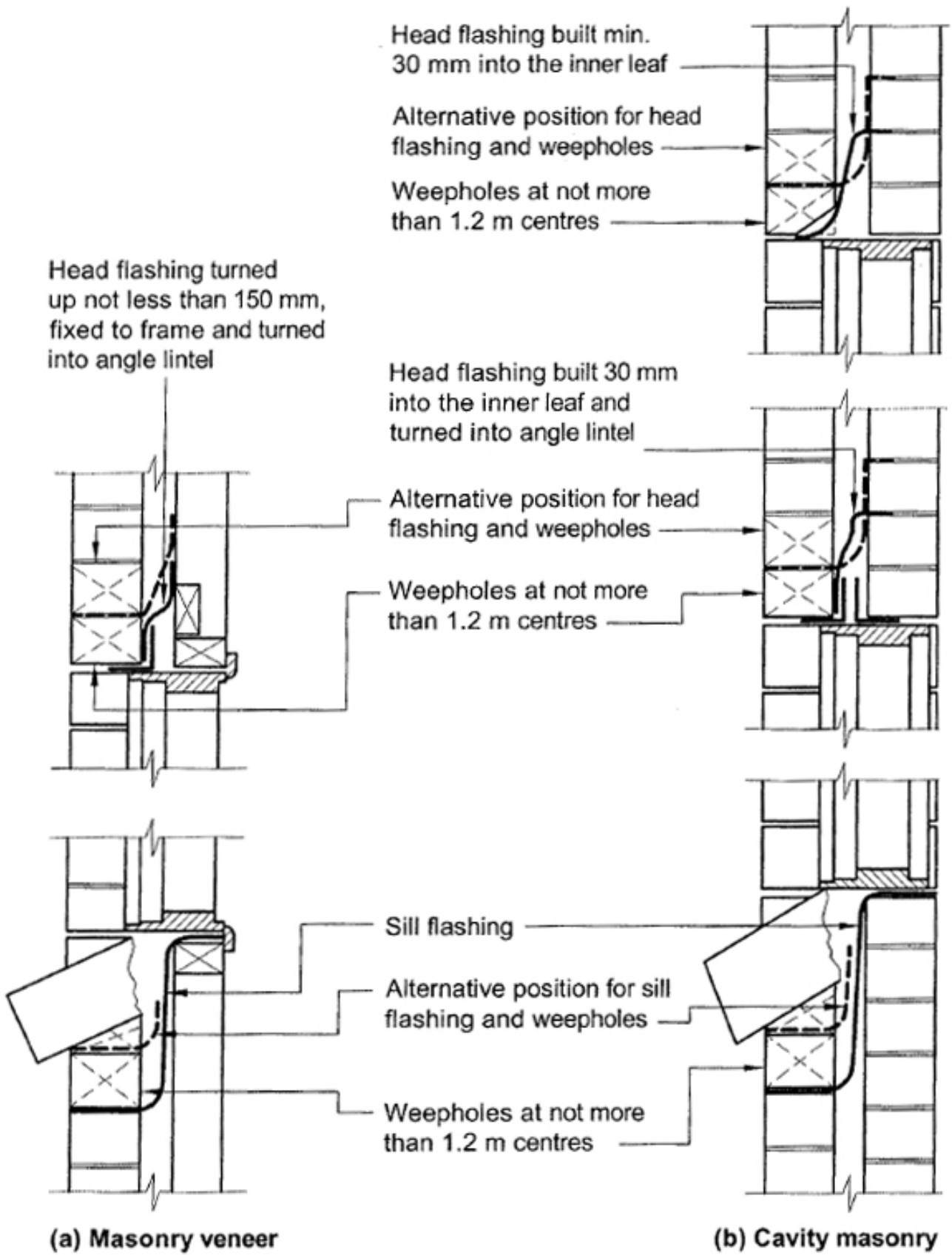

7. ROOF / WALL JUNCTIONS - BCA DIAGRAM

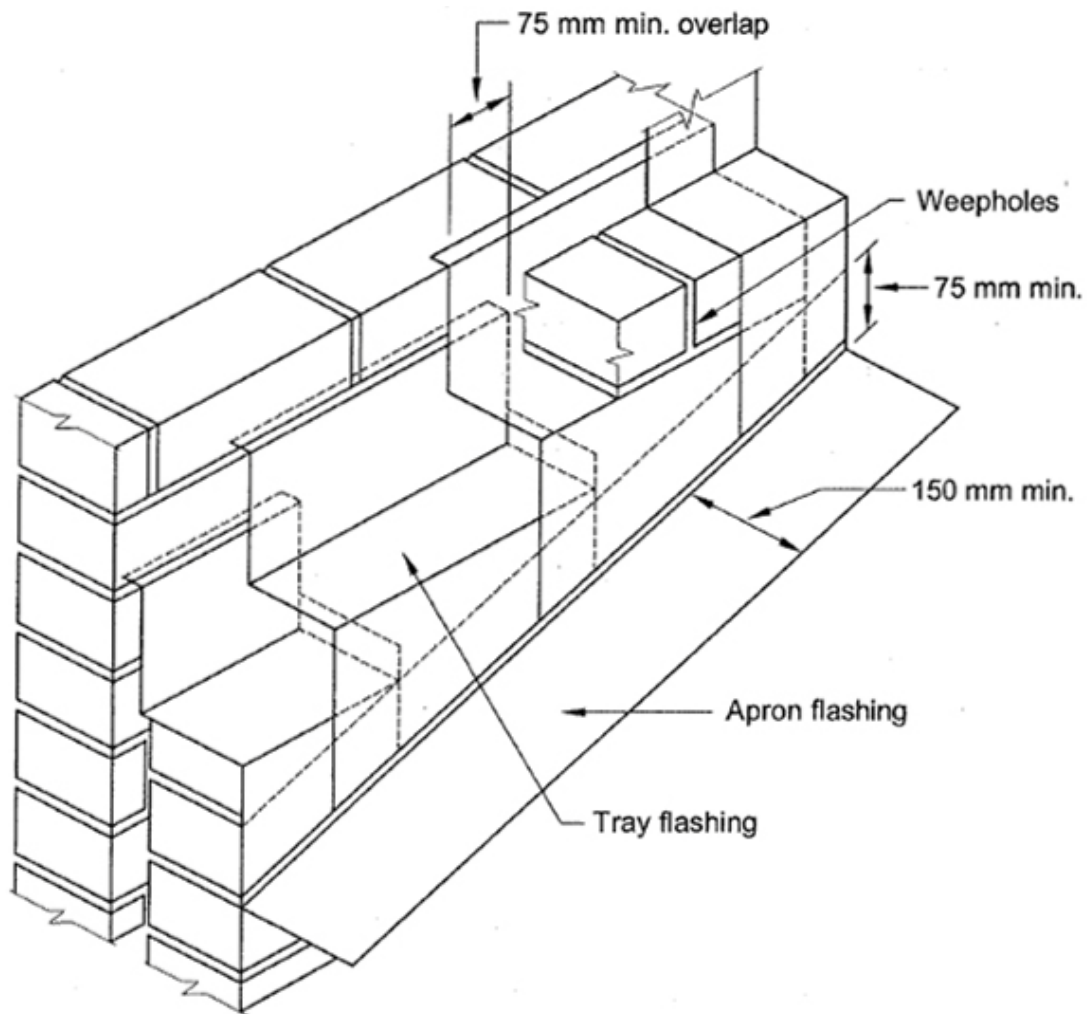

8. STEPPED CAVITY FLASHINGS - BCA DIAGRAM

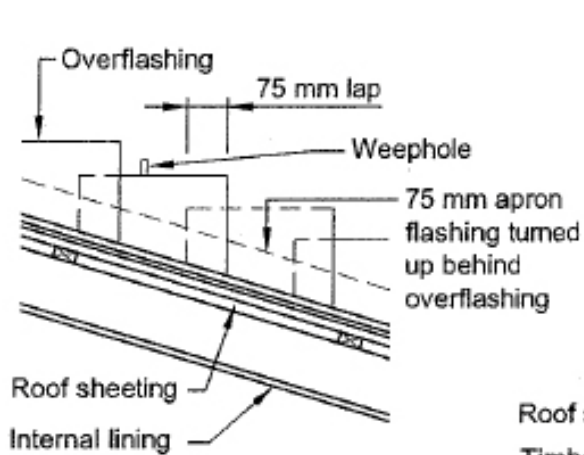

(a) Elevation view

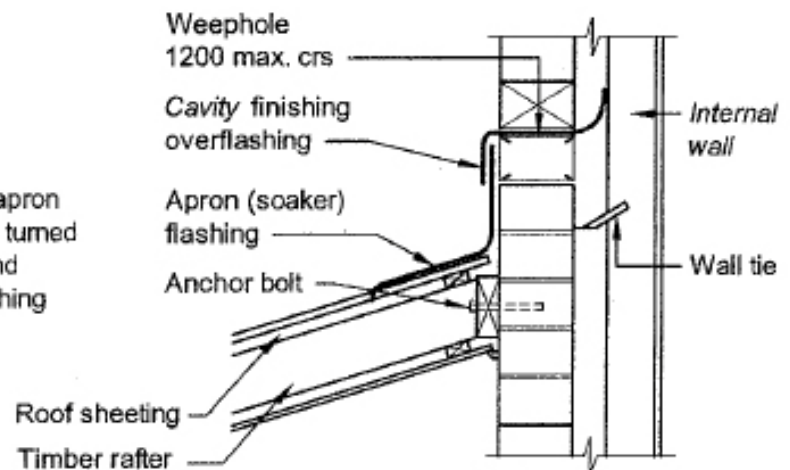

(b) Section view

9. BAL - 29

Roof finishing products such as flashings are not considered 'in isolation' in terms of BAL assessment; it is the roof system which must meet the assessment of the site. New homes, or existing residential premises to be renovated/extended must undergo a BAL assessment as part of the application for a building permit. This is a site assessment which will determine the construction methods that must be used to ensure appropriate protection from bushfires. The assessment takes into account such factors as the Fire Danger Index; the terrain; the types of surrounding vegetation; the proximity of that vegetation to the building; and normally prevailing wind directions(s). It is the responsibility of a building surveyor to use AS3959 to ensure compliance with the construction requirements of the standard.

Wakaflex lead-free flashing has been tested by CSIRO (Test report EP121796) in accordance with AS1530.8.1 and has been assessed as suitable to the regulatory requirements attached to BAL - 29 assessed construction when correctly installed totally flush to the host roof system. Cavities of any kind (voids) are **NOT** to be left between the Wakaflex lead-free flashing and the host roof components (tile/slate/steel, etc).

To accord to BAL - 29 installation of Wakaflex lead-free flashing must be as show in the following sketches:

FIGURE 1. Cross section of a tile to brick wall system with mechanical over flashing.

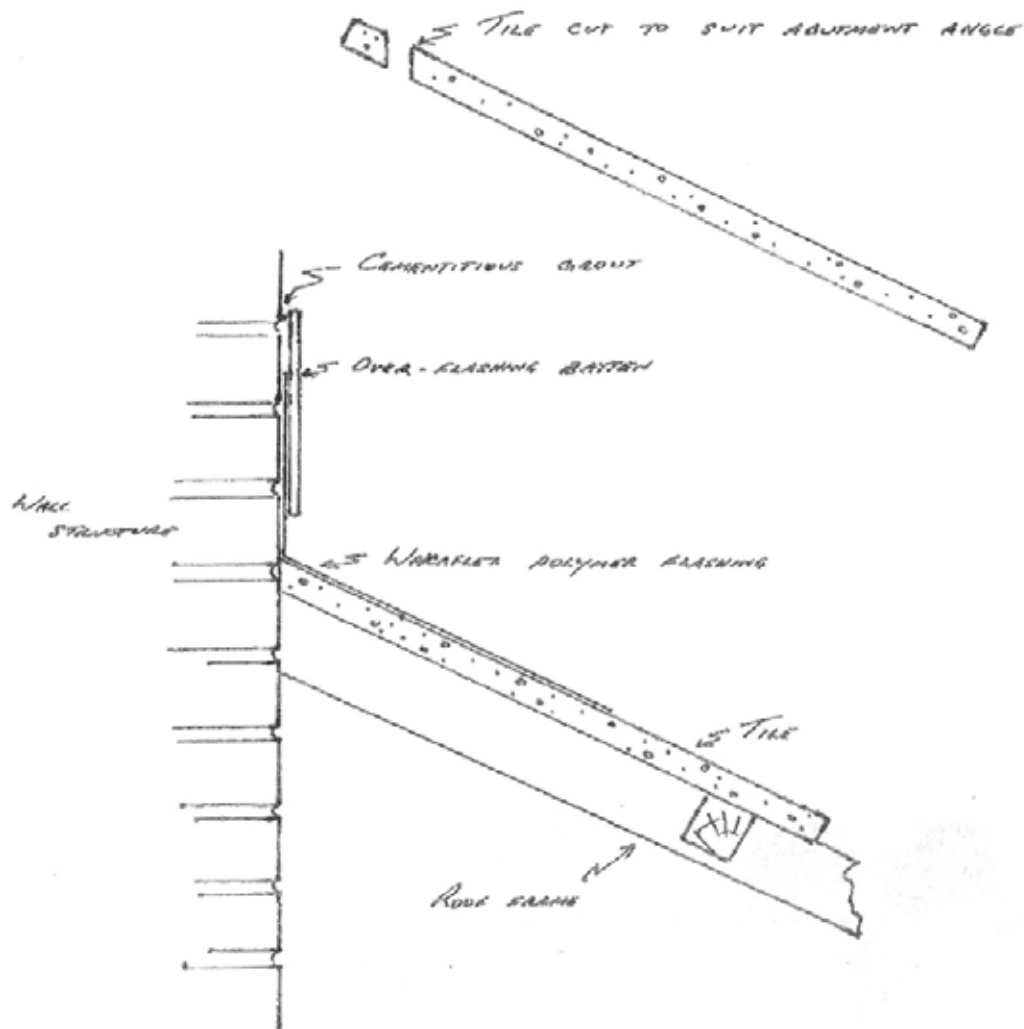

FIGURE 2. Cross section of a tile to brick wall system with flashing chased into wall.

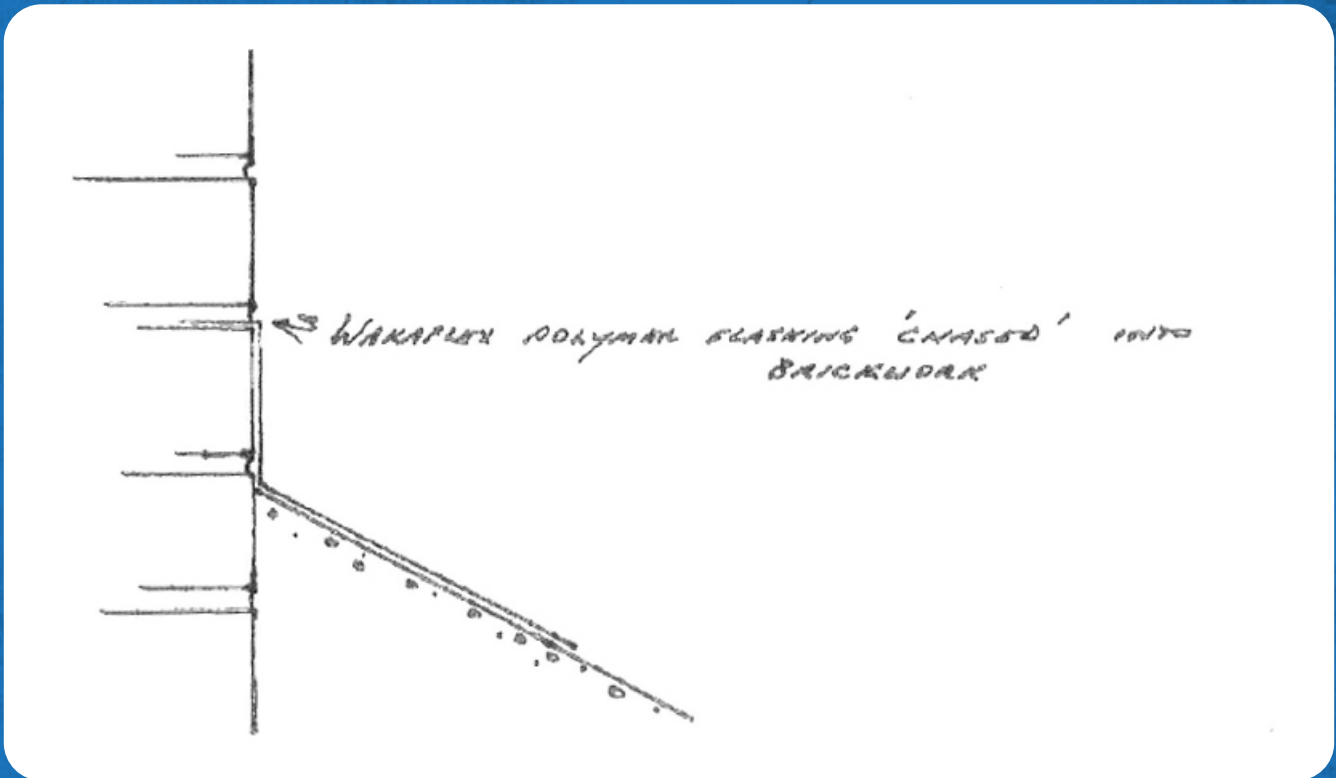

FIGURE 3. Cross section of a tile to brick wall system with grout at brick/tile interface.

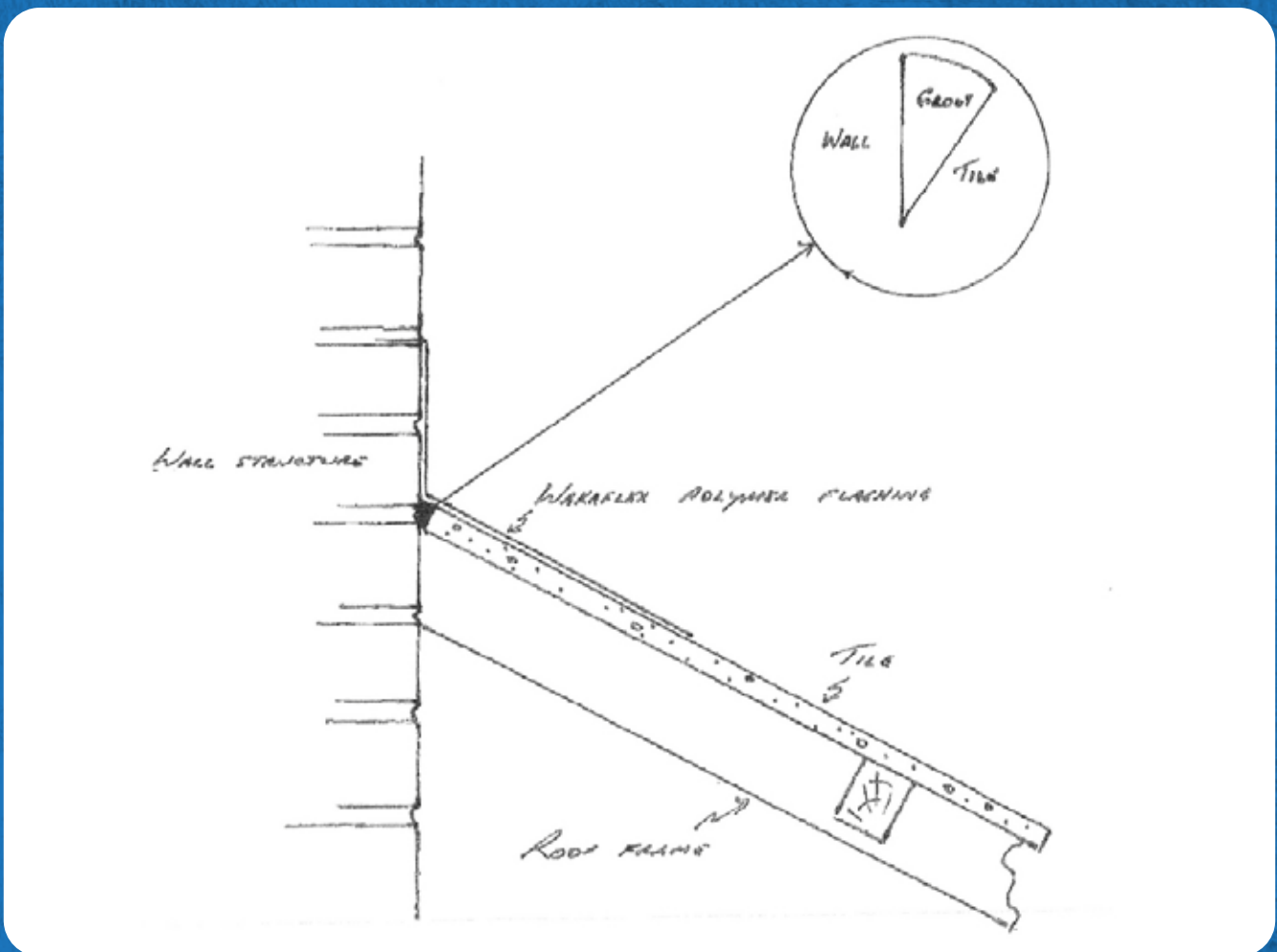

FIGURE 4. Cross section of a two floor system. Lower level brick veneer and upper level cladding façade.

